

SUCT203 SNR

Ball bearing units

TYPE: Housing units, Take-up housing units, Cast iron housing, Radial insert ball bearing with grub screws in inner ring, With inner ring extended on both sides, for tensioning frame, stainless steel

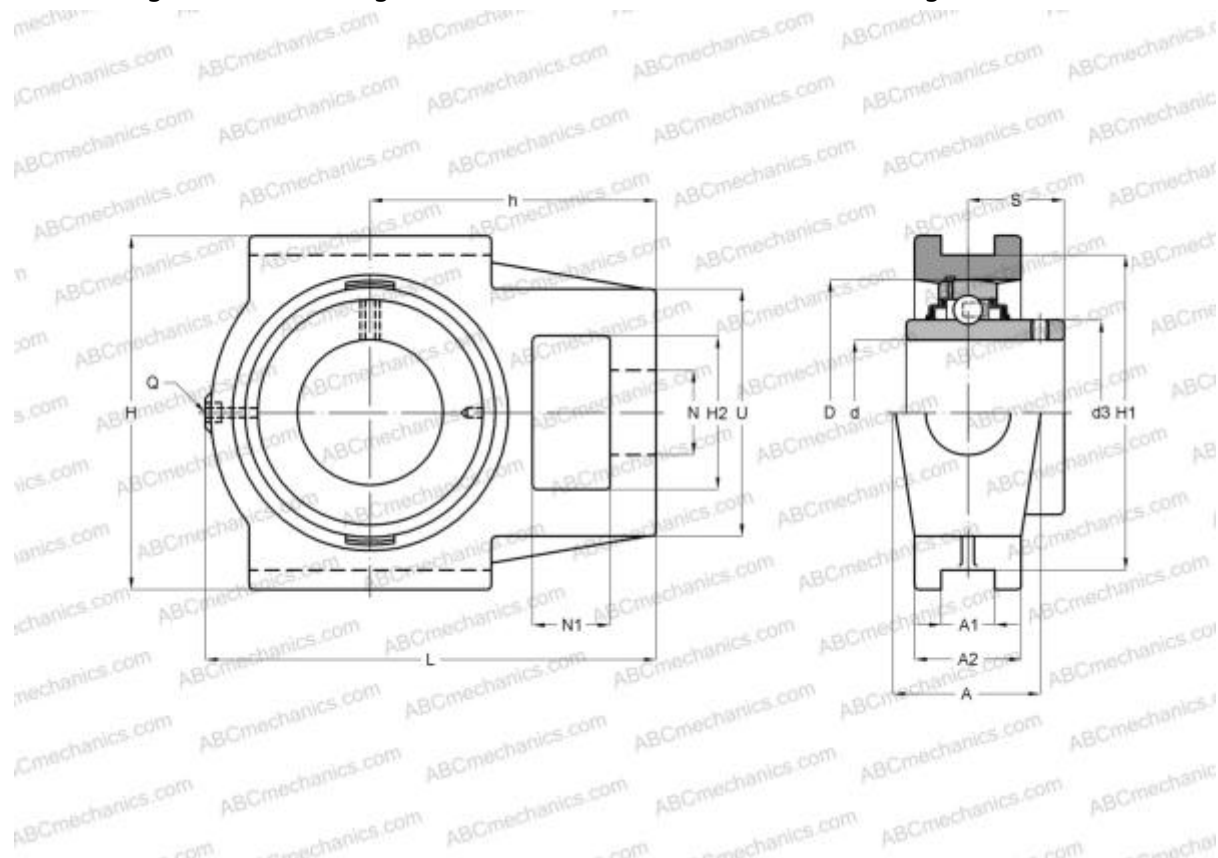

Technical specification

DIMENSIONS, MM

d	17,000
D	47,000
B	31,000
L	94,000
H	89,000
A	32,000
H2	32,000
A1	12,000
A2	21,000
H1	76,000
N	19,000
N1	16,000
S	18,300
U	51,000
h	61,000

WEIGHT, KG

	0,810
Bearing	SUC203
Housing	ST204

MANUFACTURER

[SNR](#)

INTERCHANGE

ABC	SUCT203
-----	-------------------------

CALCULATION DATA

Operating temperature min	-20 °C
Operating temperature max	120 °C