

SUCT205-16 ABC

Ball bearing units

TYPE: Housing units, Take-up housing units, Cast iron housing, Radial insert ball bearing with grub screws in inner ring, With inner ring extended on both sides, for tensioning frame, stainless steel, inch size

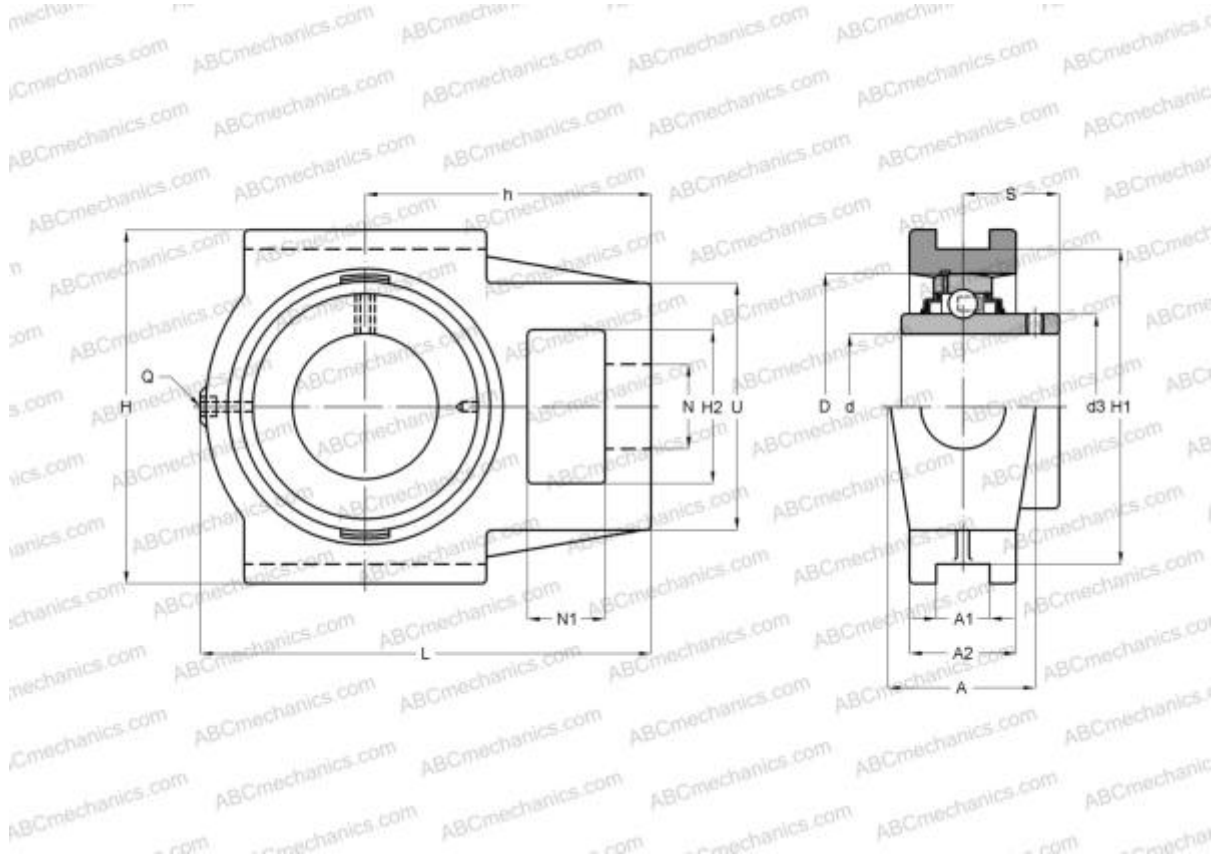

Technical specification

DIMENSIONS, MM

d	25,400
D	52,000
B	34,100
L	97,000
H	89,000
A	32,000
H2	32,000
A1	12,000
A2	24,000
H1	76,000
N	19,000
N1	16,000
S	19,800
U	51,000
h	62,000

WEIGHT, KG

Bearing	SUCT205-16	0,880
Housing	ST205	

MANUFACTURER

[ABC](#)

INTERCHANGE

SNR	SUCT205-16
-----	----------------------------