

SUCT207-22 SNR

Ball bearing units

TYPE: Housing units, Take-up housing units, Cast iron housing, Radial insert ball bearing with grub screws in inner ring, With inner ring extended on both sides, for tensioning frame, stainless steel, inch size

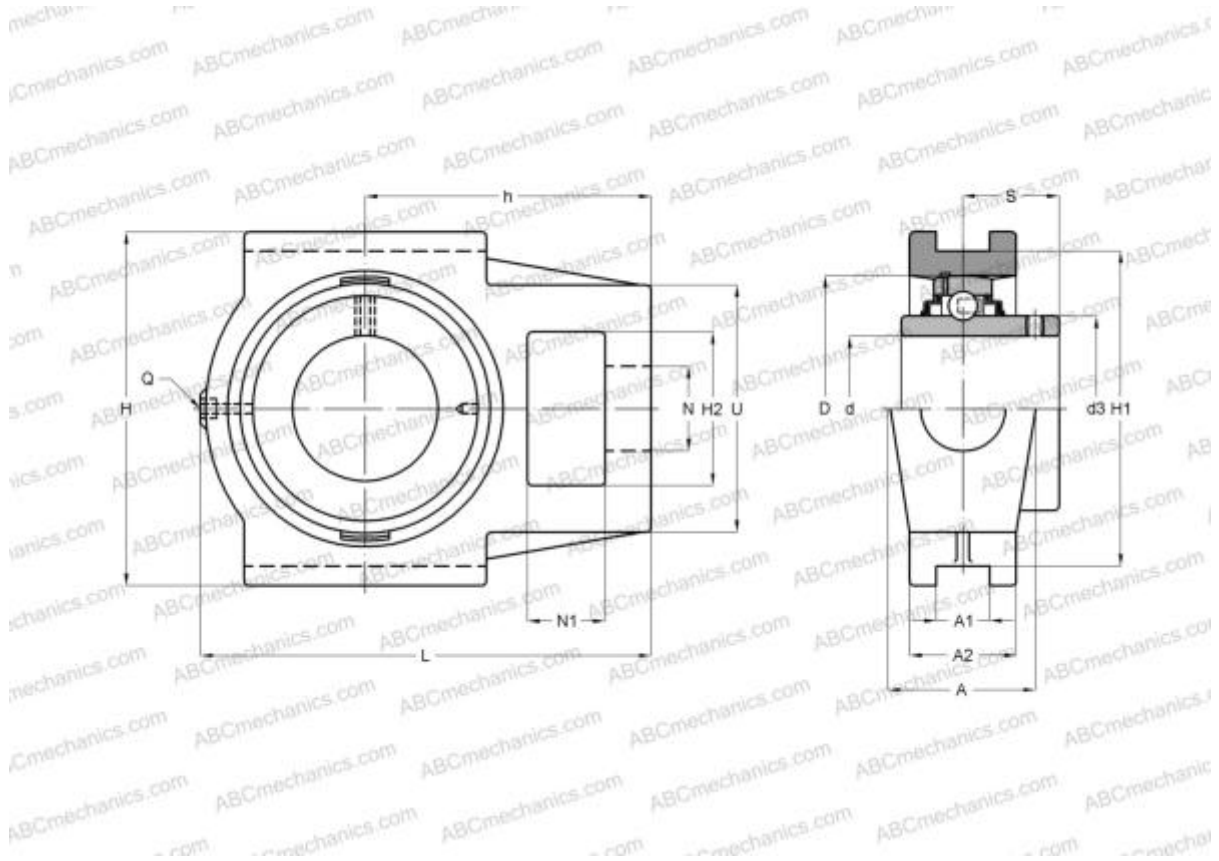

Technical specification

DIMENSIONS, MM

d	34,925
D	72,000
B	42,900
L	129,000
H	102,000
A	37,000
H2	37,000
A1	12,000
A2	30,000
H1	89,000
N	22,000
N1	16,000
S	25,400
U	64,000
h	78,000

WEIGHT, KG

Bearing	1,720
Housing	SUCT207-22
	ST207

MANUFACTURER

[SNR](#)

INTERCHANGE

ABC	SUCT207-22
-----	----------------------------

CALCULATION DATA

Operating temperature min	-20 °C
Operating temperature max	120 °C