

UCFX06 SLB

Ball bearing units

TYPE: Housing units, Four-bolt flanged housing units, Cast iron housing, Radial insert ball bearing with grub screws in inner ring, With inner ring extended on both sides, medium duty

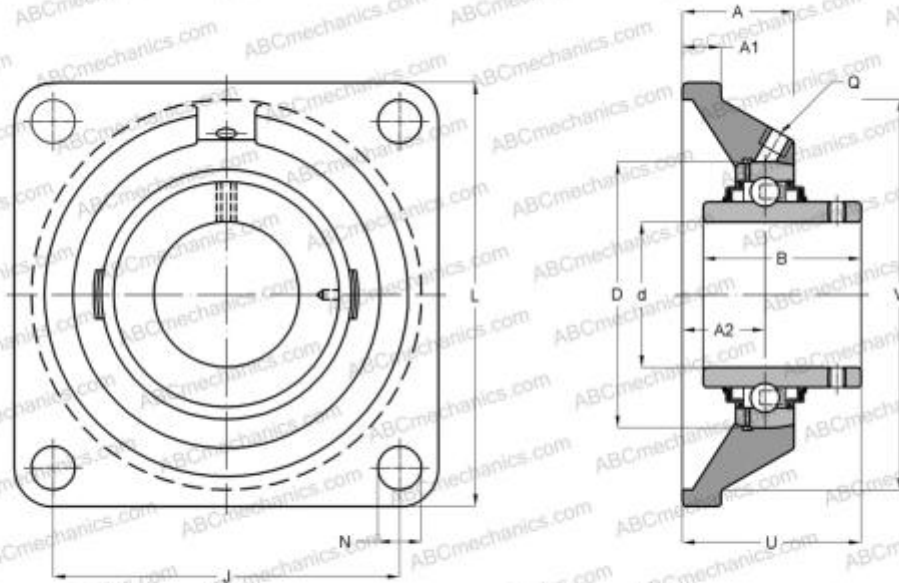

Technical specification

DIMENSIONS, MM

d	30,000
D	72,000
B	42,900
L	117,000
A	34,000
J	92,000
A1	14,000
A2	19,000
N	16,000
U	44,400

WEIGHT, KG

	1,300
Bearing	UC X06
Housing	F X06

MANUFACTURER

[SLB](#)

INTERCHANGE

ABC	UCF X06
ASAHI	UCF X06
FYH	UCFX06
NTN	UCFX 06 D1