

UCFL X06 ASAHI

Ball bearing units

TYPE: Housing units, Two-bolt flanged housing units, Cast iron housing, Radial insert ball bearing with grub screws in inner ring, With inner ring extended on both sides, massive bearing units, medium duty

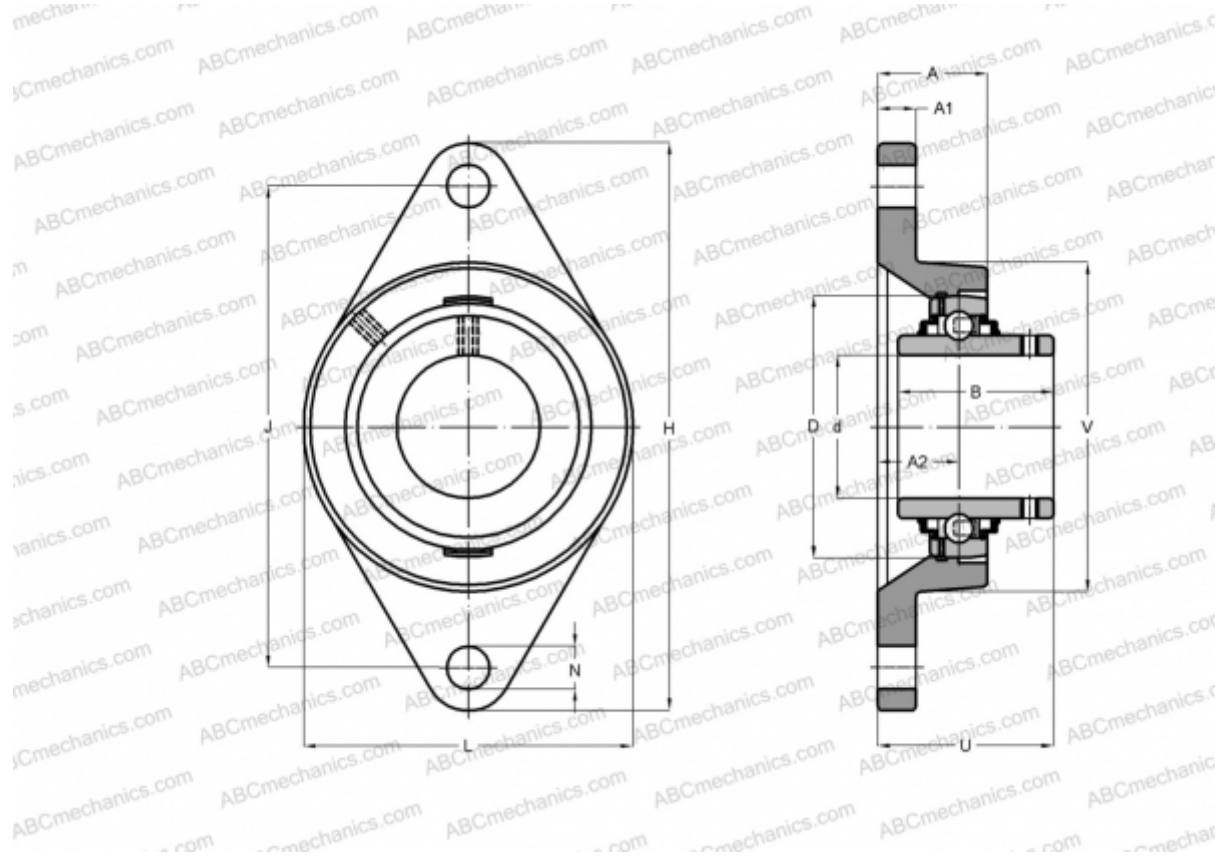

Technical specification

DIMENSIONS, MM

d	30,000
D	72,000
B	42,900
L	95,000
H	156,000
A	34,000
J	130,000
A1	14,000
A2	17,500
N	16,000
U	44,400

WEIGHT, KG 1,400

Bearing UC X06

Housing FL X06

MANUFACTURER

[ASAHI](#)

INTERCHANGE

ABC	UCFL X06
SLB	UCFL X06
FYH	UCFL X06
NTN	UCFL X06 D1