

UCPA202 SLB

Ball bearing units

TYPE: Housing units, Plummer block, Narrow cast iron housing, Radial insert ball bearing with grub screws in inner ring, With inner ring extended on both sides, massive bearing units

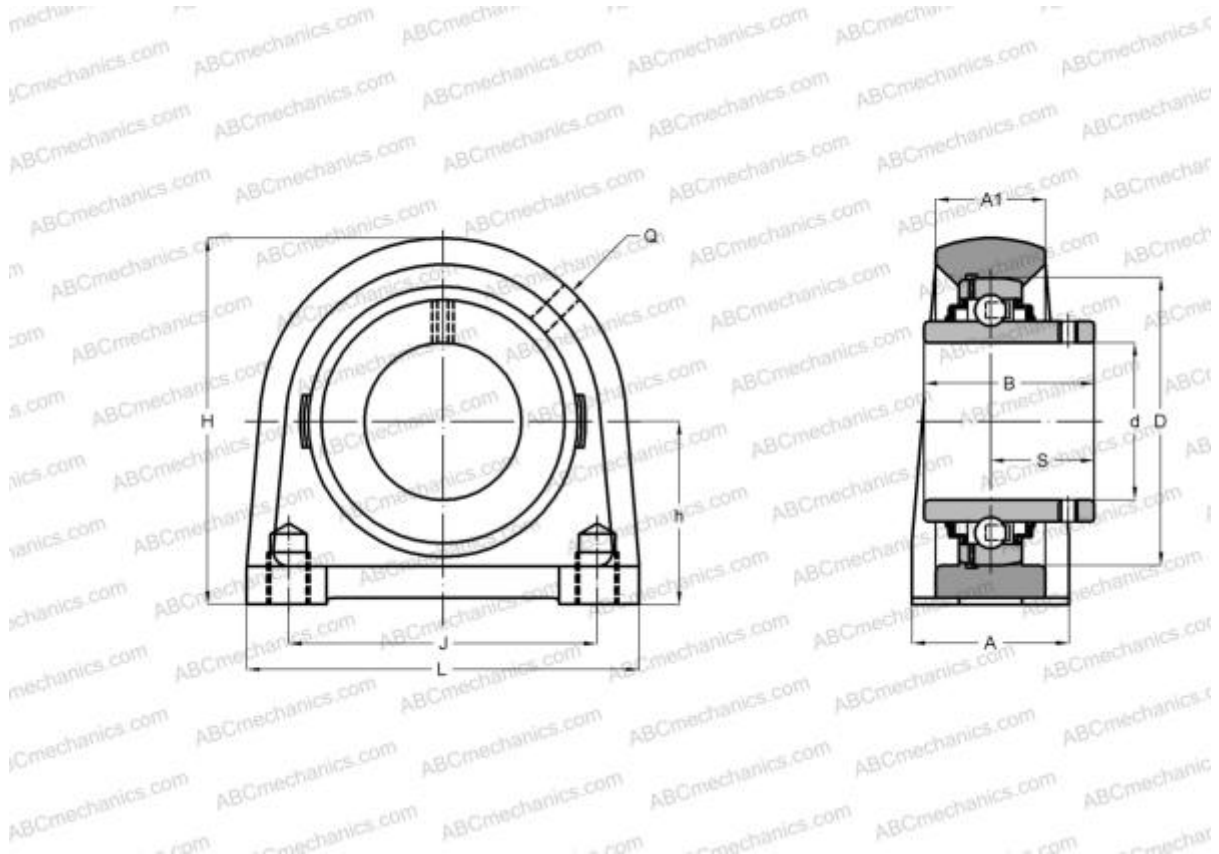

Technical specification

DIMENSIONS, MM

d	15,000
D	47,000
B	31,000
L	76,000
H	62,000
A	40,000
J	52,000
A1	22,000
H1	11,000
S	18,300
h	30,200
Q	M6x1

WEIGHT, KG 0,600

Bearing	UC202
Housing	PA204

MANUFACTURER

[SLB](#)

INTERCHANGE

ABC	UCPA202
ASAHI	UCPA 202
SNR	UCPA202
FYH	UCPA202
NTN	UCUP202 D1