

UCFL 202 D1 NTN

Ball bearing units

TYPE: Housing units, Two-bolt flanged housing units, Cast iron housing, Radial insert ball bearing with grub screws in inner ring, With inner ring extended on both sides, massive bearing units

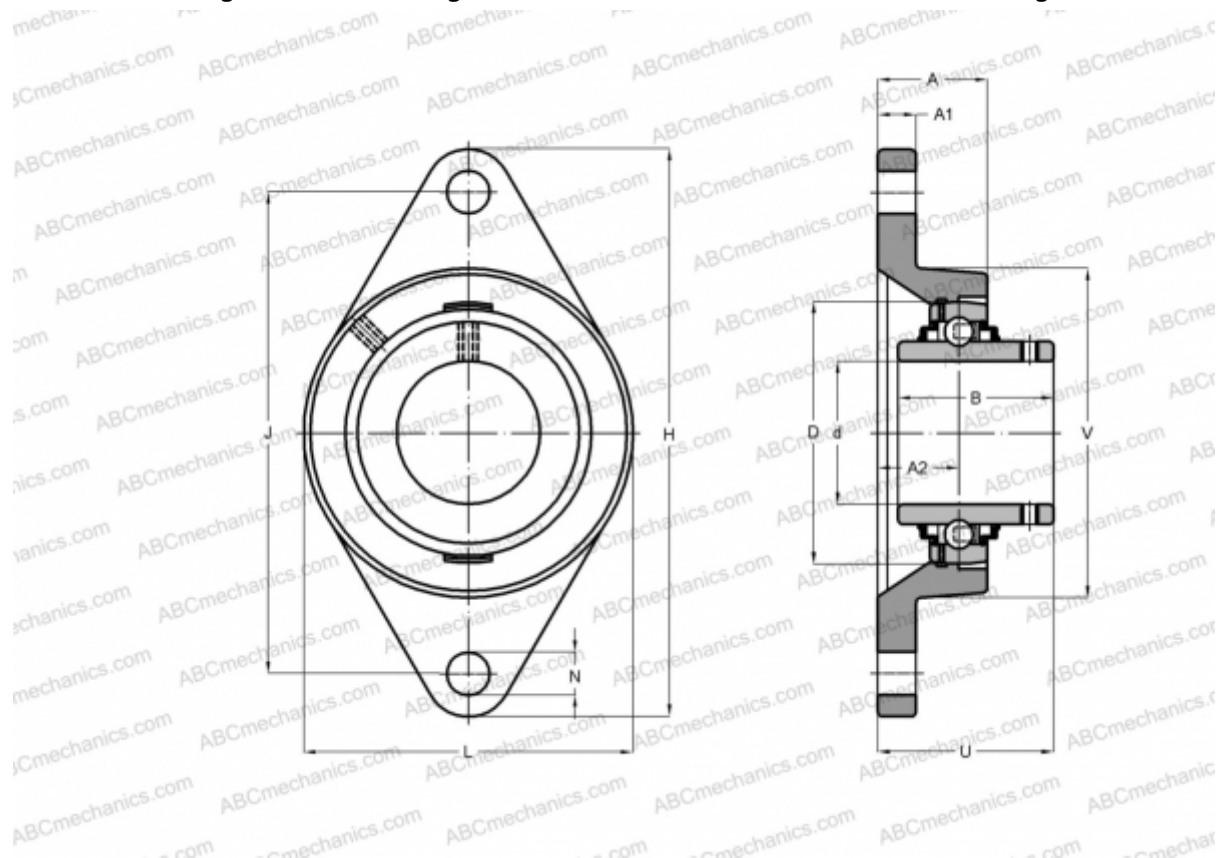

Technical specification

DIMENSIONS, MM

d	15,000
D	47,000
B	31,000
L	60,000
H	113,000
A	25,500
J	90,000
A1	11,000
A2	15,000
N	12,000
S	12,700
U	33,300
Q	M6x1

Bearing	UC202
Housing	FL204

MANUFACTURER

[NTN](#)

INTERCHANGE

ABC	UCFL202
ASAHI	UCFL 202
SNR	UCFL202
SLB	UCFL 202
FYH	UCFL 202

WEIGHT, KG

0,500