

UKFL 205 FYH

Ball bearing units

TYPE: Housing units, Two-bolt flanged housing units, Cast iron housing, Radial insert ball bearing with adapter sleeve, With inner ring extended on both sides, massive bearing units

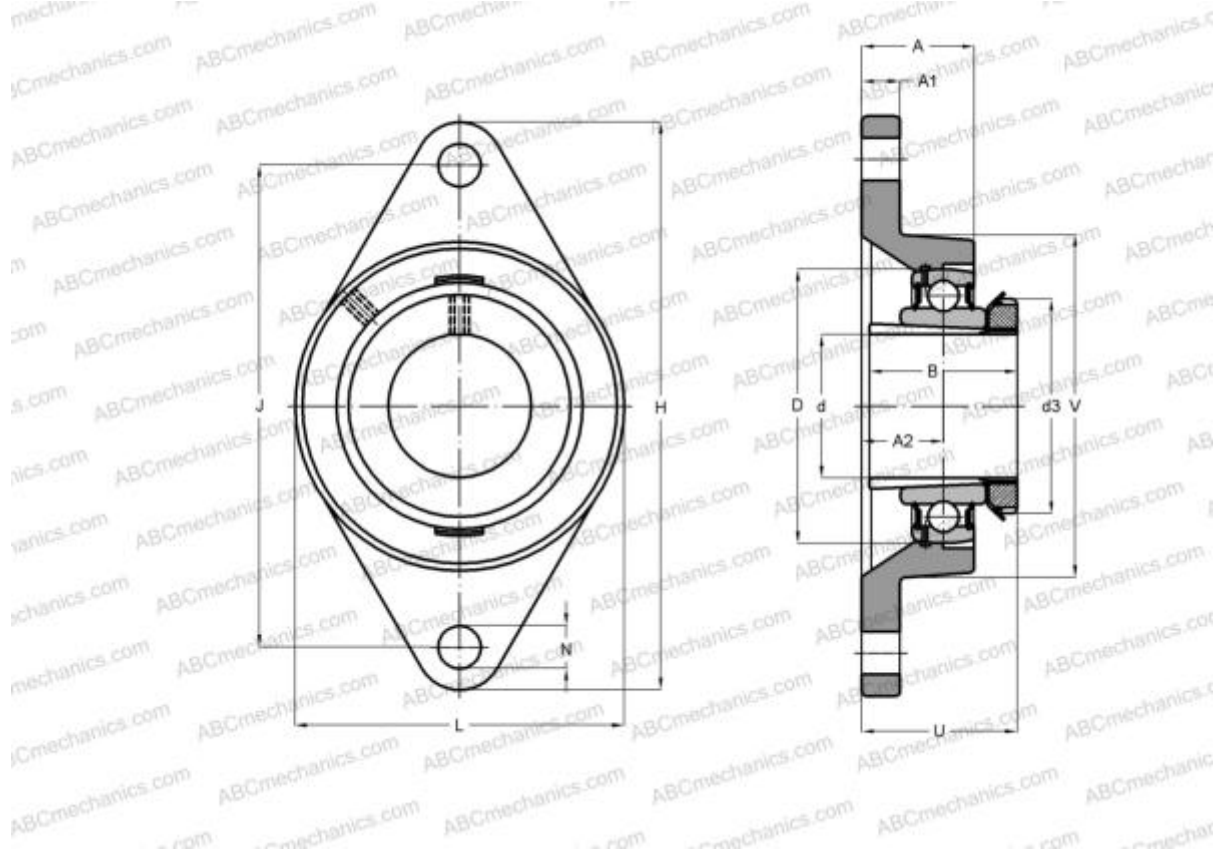

Technical specification

DIMENSIONS, MM

d	20,000
D	52,000
B	35,000
L	68,000
H	130,000
A	27,000
J	99,000
A1	13,000
A2	16,000
N	16,000
d3	38,000
U	34,500
Q	M6x1

WEIGHT, KG 0,700

Bearing	UK205 +
Housing	FL205
Adapter sleeve	H2305

MANUFACTURER

[FYH](#)

INTERCHANGE

ABC	UKFL205H
SNR	UKFL205H
SLB	UKFL 205
NTN	UKFL 205 D1