

SBPF 202 FYH

Ball bearing units

TYPE: Housing units, Three/four-bolt flanged housing units, Sheet steel housing, Radial insert ball bearing with grub screws in inner ring, With inner ring extended at one side

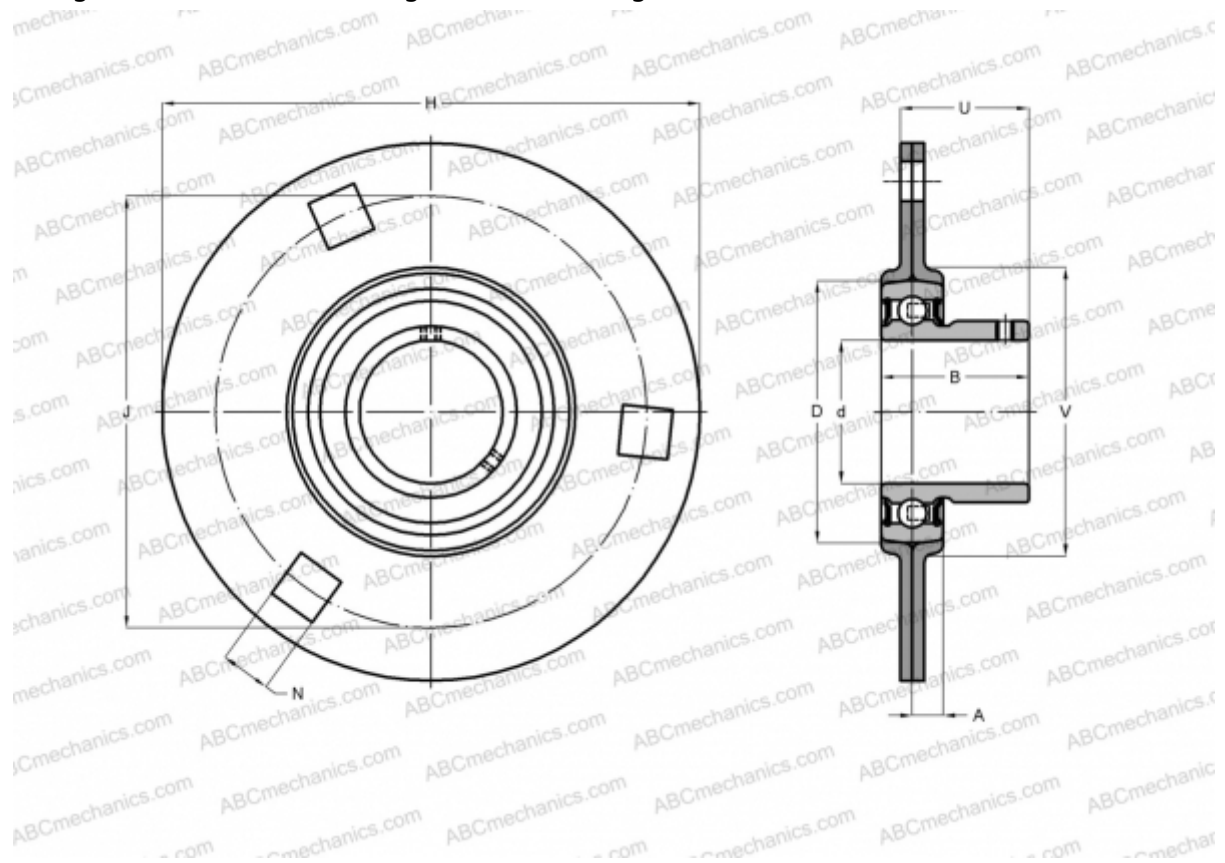

Technical specification

DIMENSIONS, MM

d	15,000
D	40,000
B	22,000
H	81,000
A	6,700
J	63,500
N	7,100
V	49,000

WEIGHT, KG

Bearing	US202
Housing	PF203

MANUFACTURER

[FYH](#)

INTERCHANGE

ABC	USPF202
ASAHI	BPF 2
INA	RAY15
SNR	USPF202
SLB	SBPF 202
NTN	ASPF 202