

UKF205 FYH

Ball bearing units

TYPE: Housing units, Four-bolt flanged housing units, Cast iron housing, Radial insert ball bearing with adapter sleeve, With inner ring extended on both sides

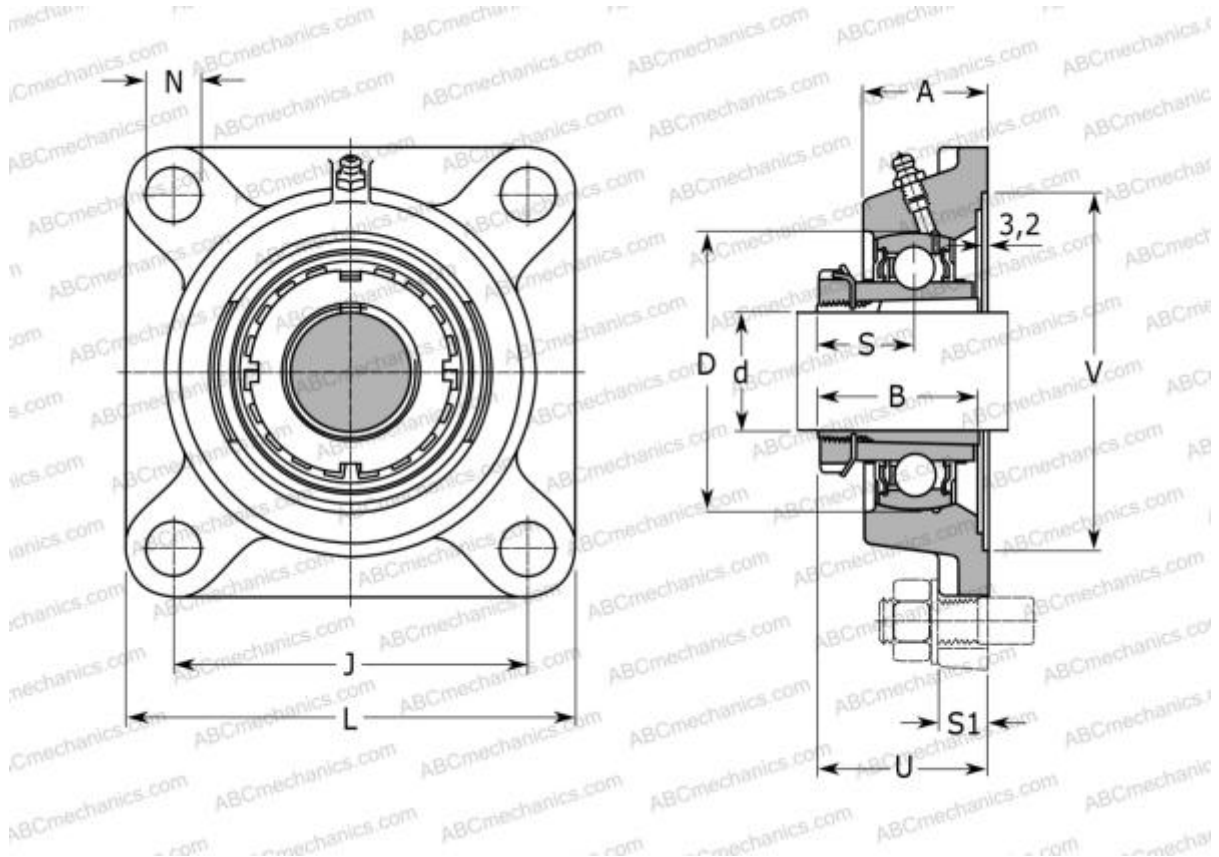

Technical specification

DIMENSIONS, MM

d	20,000
D	52,000
B	35,000
L	95,000
A	27,000
J	70,000
A1	13,000
A2	16,000
N	12,000
d3	38,000
U	34,500
Q	M6x1

WEIGHT, KG 0,800

Bearing	UK205 +
Housing	F205
Adapter sleeve	H2305

MANUFACTURER

[FYH](#)

INTERCHANGE

ABC	UKF205H
ASAHI	UKF 205 + H2305
SNR	UKF205H
SLB	UKF 205
NTN	UKF 205 D1