

UCHA202 FYH

Ball bearing units

TYPE: Housing units, Take-up housing units, Cast iron housing, Radial insert ball bearing with grub screws in inner ring, With inner ring extended on both sides, bracket

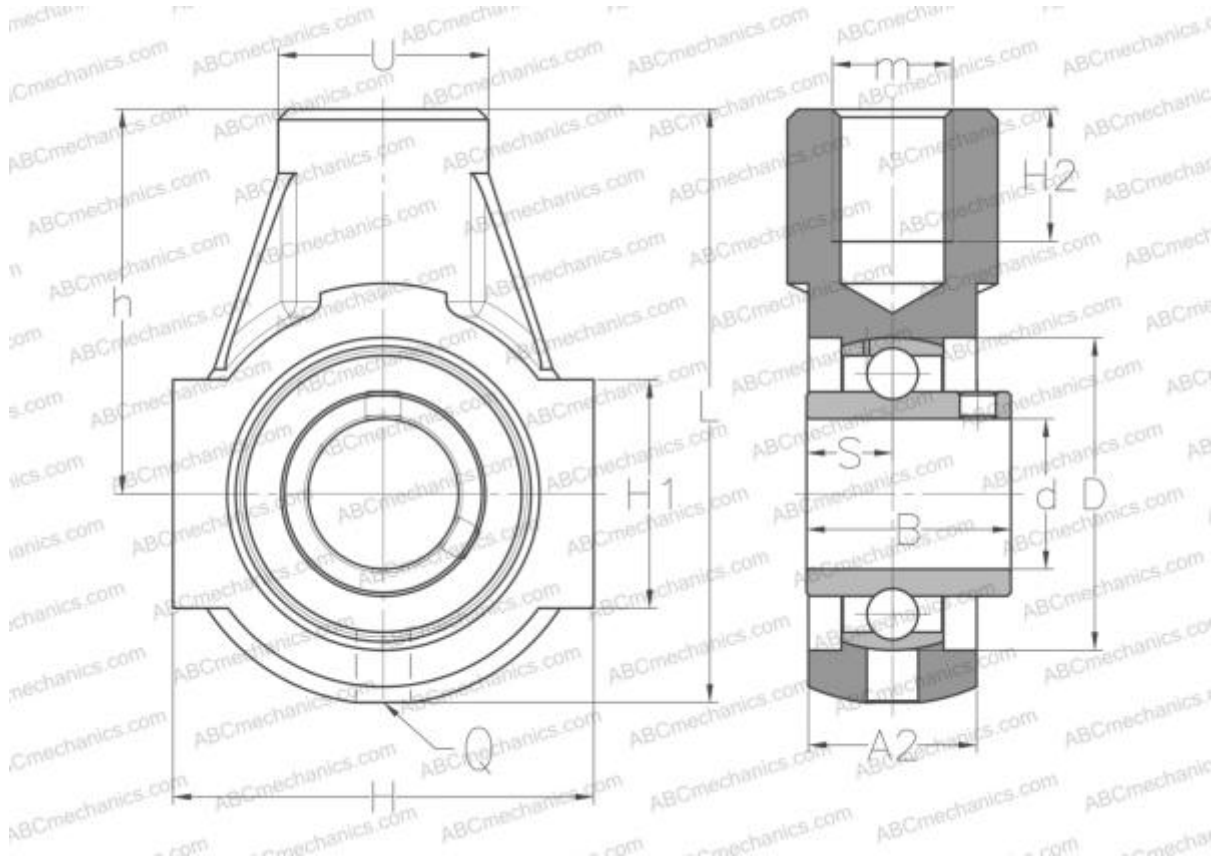

Technical specification

DIMENSIONS, MM

d	15,000
D	47,000
B	31,000
L	91,000
H	65,000
H2	21,000
A2	25,000
H1	38,000
S	12,700
U	30,000
h	58,000
m	M16
Q	R1/8"

Bearing	UC202
Housing	EHE204

MANUFACTURER

[FYH](#)

INTERCHANGE

ABC	UCEHE202
SNR	UCEHE202
SLB	UCHA202
NTN	UCHB 202 D1

WEIGHT, KG 0,800