

UCC 201 D1 NTN

Ball bearing units

TYPE: Housing units, Cartridge units, Cast iron housing, Radial insert ball bearing with grub screws in inner ring, With inner ring extended on both sides

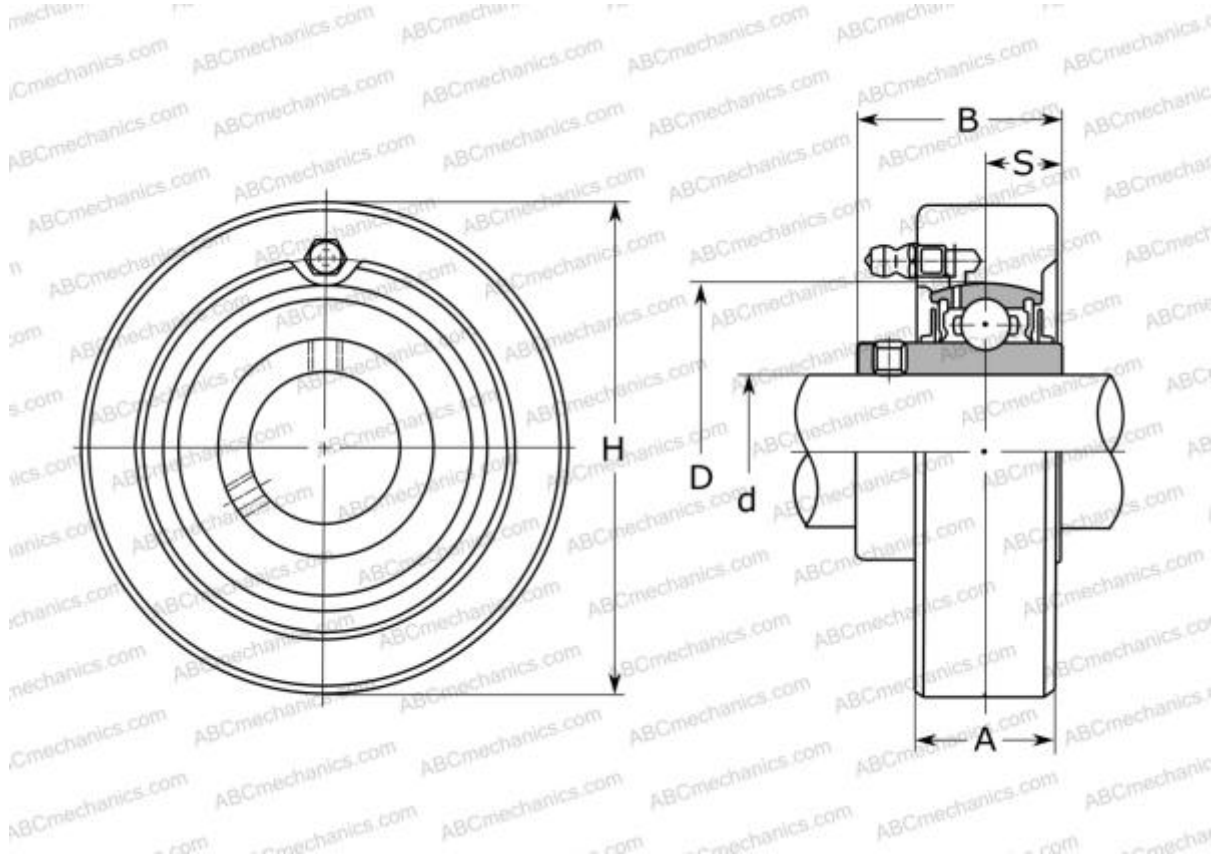

Technical specification

DIMENSIONS, MM

d	12,000
D	47,000
B	31,000
H	72,000
A	20,000
S	12,700
Q	M6x1

WEIGHT, KG	0,500
Bearing	UC201
Housing	C204

MANUFACTURER [NTN](#)

INTERCHANGE

ABC	UCC201
ASAHI	UCC 201
SNR	UCC201
SLB	UCC 201
FYH	UCC201