

## RATY17 INA

Ball bearing units

TYPE: Housing units, Two-bolt flanged housing units, Sheet steel housing, Radial insert ball bearing with grub screws in inner ring, Type RATY (INA)

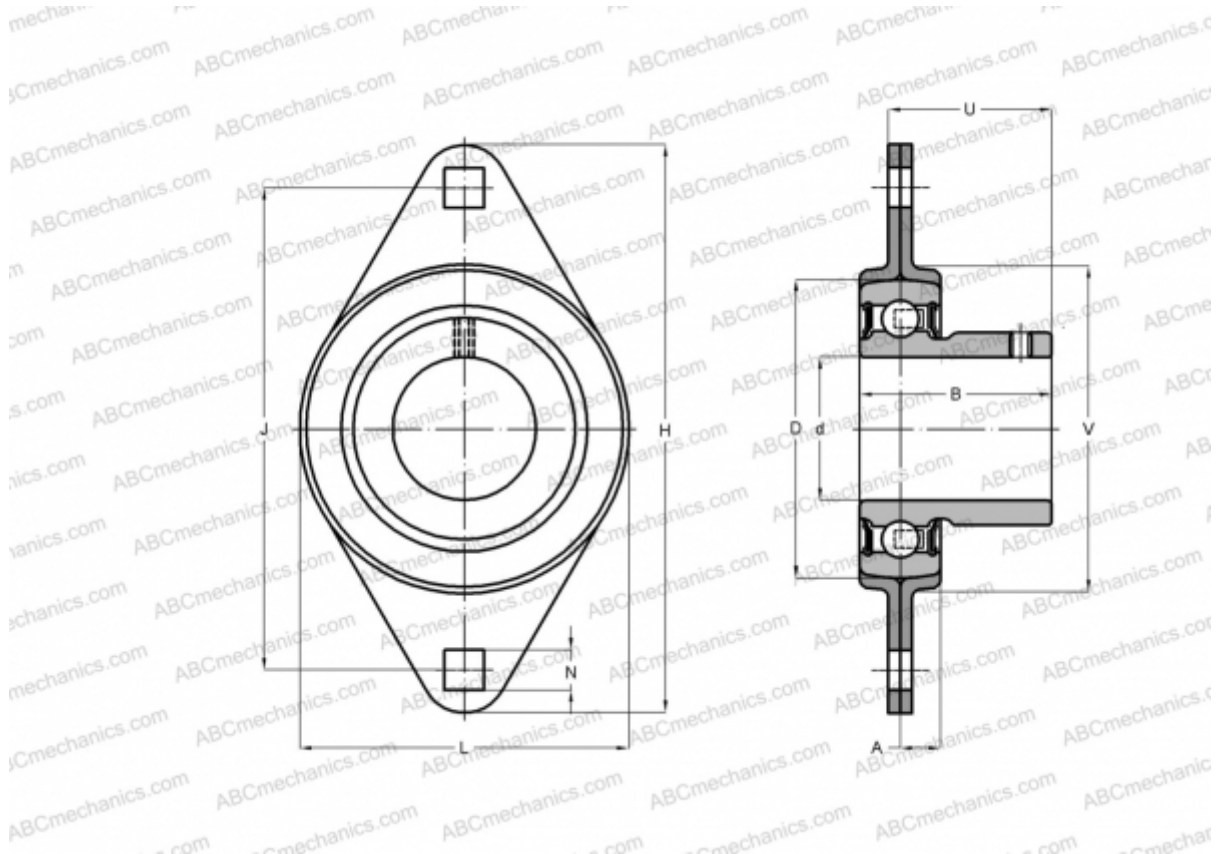

### Technical specification

#### DIMENSIONS, MM

d	17,000
D	40,000
B	22,000
L	58,700
H	81,000
A	7,000
J	63,500
N	7,100
U	18,000
V	48,000

**WEIGHT, KG** 0,120

Bearing	AY17-NPP-B
Housing	FLAN40-MST x

#### MANUFACTURER

[INA](#)

#### INTERCHANGE

INA FLAN40-MST x 2 + AY17-NPP-B