

RATY25 INA

Ball bearing units

TYPE: Housing units, Two-bolt flanged housing units, Sheet steel housing, Radial insert ball bearing with grub screws in inner ring, Type RATY (INA)

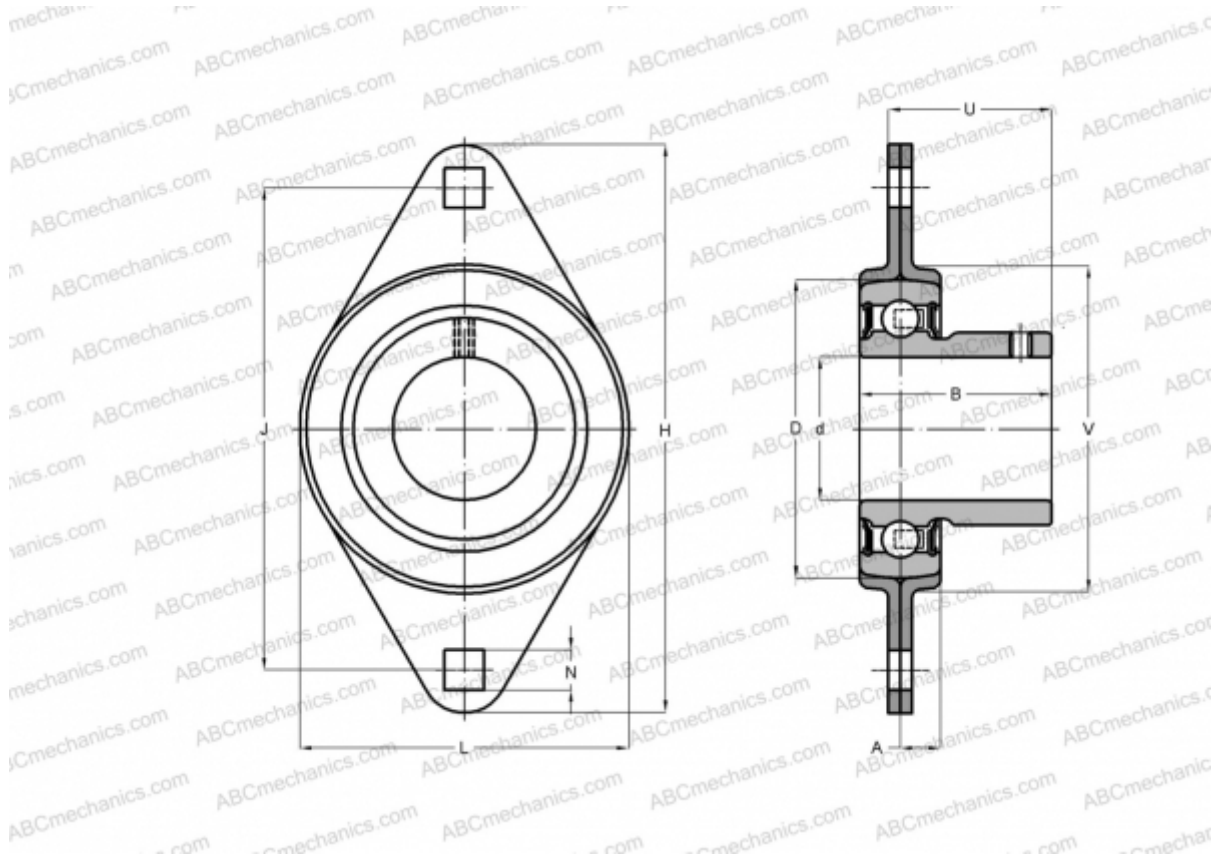

Technical specification

DIMENSIONS, MM

d	25,000
D	52,000
B	27,000
L	71,000
H	95,200
A	8,700
J	76,200
N	8,700
U	21,500
V	60,000

MANUFACTURER

[INA](#)

INTERCHANGE

INA FLAN52-MST x 2 + AY25-NPP-B

WEIGHT, KG

0,260

Bearing	AY25-NPP-B
Housing	FLAN52-MST x